

ADVC Controller Range



Advancing Your Network



schneider-electric.com

Life Is On

Schneider
Electric™



ADVC Controller Range

Two Controller Solutions

ADVC Compact - IP 54 Cubicle



Offering

- Superior Reliability and Performance
- Configurable User Interfaces
- Advanced Protection Features
- Enhanced Communications
- Analytical Tools

ADVC Ultra - IP 65 Cubicle

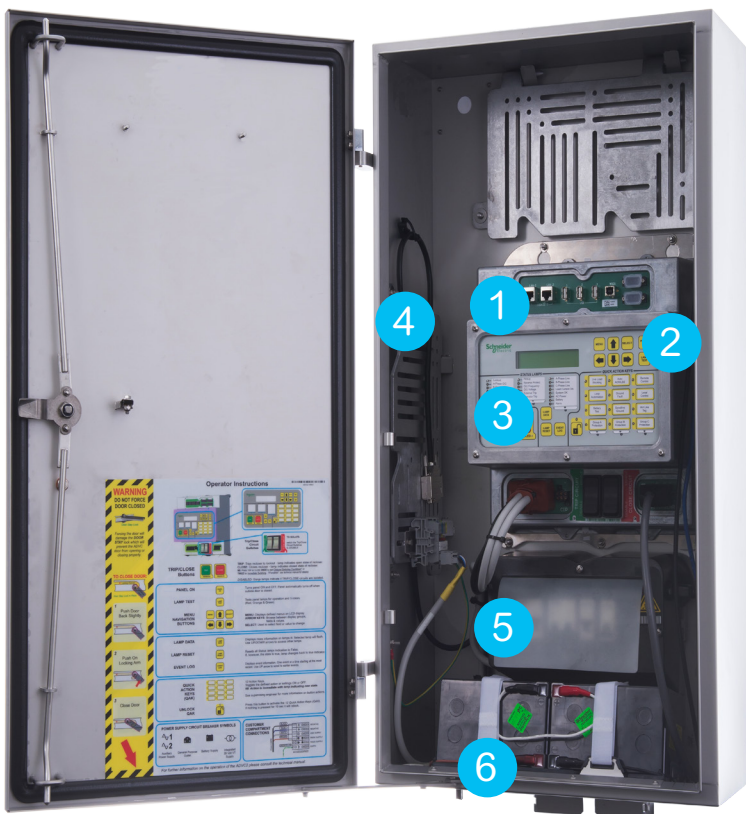

Ensuring Reliability

- IP 65 rated electronics enclosure
- IP rated Stainless Steel Cubicles
- Ventilation allowing natural air flow
- 3-point locking system for ADVC ULTRA
- 2-point for ADVC COMPACT

1 All-In-One CAPE

An IP65 rated CAPE (Control And Protection Enclosure) made from die cast aluminium, incorporates all the control, protection, communication and power supply functions into one reliable unit.

2 Communication Ports

Standard DB9, RJ45 and USB connections are easily accessible. There is no need for complicated customised communication cables, making installation and commissioning simple.

Note: Refer page 4 for remaining numbered annotations.

3 Customised User Interface

Mounted on the CAPE, you can choose the best Operator Interface for your needs:

- Menu driven **setVUE** Interface, or
- Fully configurable **flexVUE** interface

setVUE Interface

- Menu driven interface
- Large 4 x 40 character LCD Display
- 4 Configurable quick action keys
- Simple menu navigation
- Trip/Close buttons for switch control

flexVUE Interface (pictured)

- 20 configurable status lamps
- 12 configurable quick action keys
- Label inserts to identify each lamp and QAK
- 2 x 20 character LCD display
- Trip/Close buttons for switch control

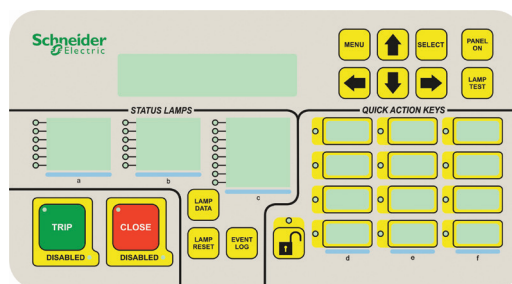
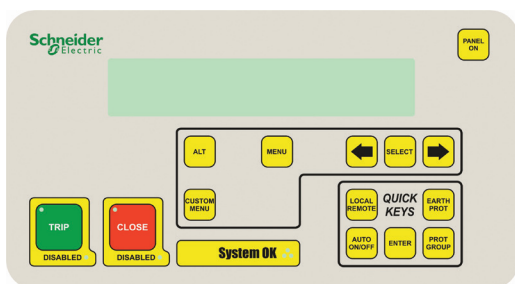

4 Customer equipment expansion

Expand your ADVC Solution into a fully integrated SCADA solution by adding modems, radios, I/O expanders and other customer accessories to the detachable accessory trays.

The sturdy cast-aluminium tray can be moved from its mounting to the front of the cubicle making commissioning and installation easier. Once all the accessories are positioned, simply move the tray back into place.

The tray design caters to a wide variety of equipment and mounting configurations.

5 Extra Power

Auxiliary power, including an optional courtesy outlet, is easily accessed with a power supply unit at the base of the cubicle. Transformers, breakers and terminals are available for auxiliary power connection, and all wiring is protected by a safe IP20-rated removable cover. A silicone rain-shield also covers the miniature circuit breakers.

6 Battery Backup

Up to 46 hours* battery hold up time without power. 2 x 12 V lead-acid batteries (at base of cubicle) provide up to 5 years trouble free operation. Both controllers offer 7 Ah batteries, and the ULTRA also offers optional

12 Ah batteries for longer hold up, and heater, for operation to -40 °C.

* **With 12 Ah Batteries. Approximately 28 Hours with 7 Ah batteries**

Features

Advancing your electricity distribution network is easily accomplished with the host of ergonomic, physical, protection/detection, automation, analytical and communication features. Designed around the user, the ADVC Controller Range provides reliable and advanced protection relays/controllers for overhead network applications.

Protection Features

- Phase over current
- Earth fault
- Sensitive earth fault
- Negative phase sequence
- Directional protection
- Directional blocking
- Cold load
- Under/over voltage
- Under/over frequency
- Rate of change of frequency
- Check sync
- Neutral voltage displacement
- Inrush restraint (zero detect/2nd harmonic)
- High current lockout
- Broken conductor
- Fault locator
- Loss of phase
- Close on fault trip
- Automatic protection group selection (up to 10 configurable protection groups)

Protection Curves

- IEC 60255 curves
 - Inverse
 - Very inverse
 - Extremely inverse
- IEEE C37.112 inverse time
 - Very inverse
 - Extremely inverse
- Curves moderately inverse
 - Very inverse
 - Extremely inverse
- 42 Non standard inverse time curves
- Per element reset curves

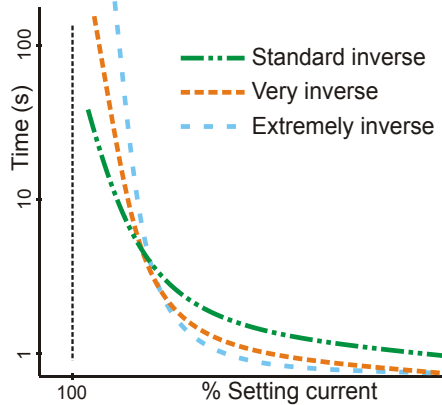

Flexibility

Extended Protection Settings

Flexibility in configuring the desired action for each of the protection elements. Choose between 'Alarm' or 'Trip'.

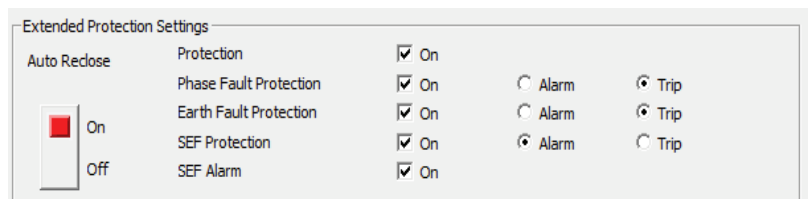

Per Trip Threshold

Choose between having a global threshold/current setting configuration for each protection element, or a setting per configured Trip.

Per Element Reclose Time

Choose between having a fixed Reclose time between each protection trip, or configure the Reclose time based on individual protection elements.

Close Block

Configure the controller to block a Close operation when the voltage or frequency are outside a configured threshold.

Automation Features

- Classic Loop Automation
- Intelligent Loop Automation
 - Peer-to-Peer communication
 - Overload Control
 - Load shed
- Auto Change Over

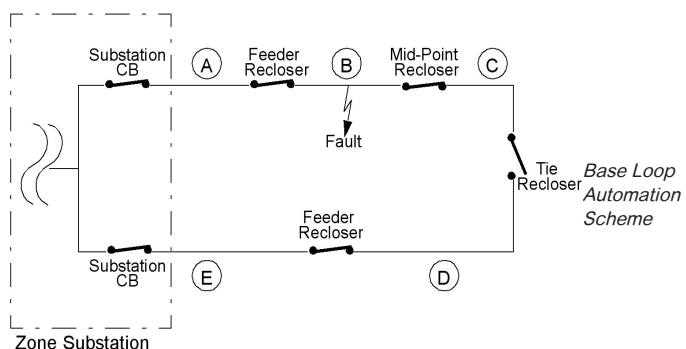

Measurements and Quality

- Voltage and current
- Frequency
- Real power (signed or unsigned)
- Power and power factor
- Power quality
 - Waveform capture
 - Harmonics
 - Sag and swell
- 100,000 Configurable history data
- 100,000 Events

Communications and Telemetry

- 2 x 100 Base-T
- 2 x RS 232
- 3 x USB 2.0 Type A
- 1 x USB 2.0 Type B
- Local/Remote
- DNP3
- Secure DNP3 (SAv5)
- Modbus
- IEC 60870-5-101/104
- NTP



Specifications

Physical Specifications	COMPACT	ULTRA
Controller weight	30 kg	34 kg
Cubicle height	730 mm	960 mm
Cubicle width	420 mm	450 mm
Cubicle depth	302 mm	302 mm
Cubicle material	304 stainless steel	316 stainless steel
Customer compartment size [mm]	70 x 270 x 200	70 x 270 x 200 & 260 x 280 x 200
Cubicle shell sealing	IP54	IP65
Electronic enclosure sealing	IP65	IP65
Wind loading resistance of structure	>160 km/hr	>160 km/hr
Wind loading on door when latched in open position	>60 km/hr	>60 km/hr
Angle of door opening	135°	135°
Operating temperature range	-10°C to 50°C	-10°C to 50°C
Extended operating temperature range with battery heater (ULTRA only)	-	-40°C to 50°C
Electronics operating temperature range	-40°C to 70°C	-40°C to 70°C
Maximum radiation	1.1 kW/m ²	1.1 kW/m ²
Humidity	0 to 100%	0 to 100%

Power Supply Specifications	COMPACT/ULTRA
Auxiliary voltage input switch selectable	115/230 VAC
Courtesy outlet rating	10 A (Option)
Real time clock hold time	20 days

Battery	COMPACT/ULTRA
Battery type (sealed lead-acid)	2 x 12 VDC
Battery capacity	7 Ah (12 Ah option on ULTRA)
Battery hold up time with panel off and without communications devices or heater at 25°C	28 hours with 7 Ah (48 hours with 12 Ah)
Capacity available for communications hold up time (Panel off, no heater or IOEX 13.8 V TX: 2.1 A, 15 min, RX 320 mA)	20 hours
Battery recharge time	
<ul style="list-style-type: none"> 7 Ah battery from new to 80% nominal capacity 12 Ah battery from new to 80% nominal capacity 	9.5 hours 13.5 hours
Battery replacement interval	5 years (Influenced by environment)

Radios or modems may be fitted for remote communications. Space, power and data interfaces are provided within the control cubicle.

Radio/modem	COMPACT/ULTRA
Radio/modem power supply voltage	5 - 15 VDC
Radio/modem power supply current	3 A cont, 8 A peak
Radio/modem power supply shut-down time	1 - 1440 mins
Radio/modem interface	RS232, Ethernet, USB 2.0

Control Electronics	COMPACT/ULTRA
Continuous primary current	800 A
Short time primary current	16 kA for 3 secs, 2000:1 CT
Short time current recovery time	60 secs
Required auxiliary supply rating	100 VA

Other	COMPACT/ULTRA
Earthing	10 mm earth stud

Life Is On

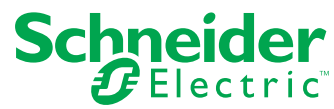

schneider-electric.com

Schneider Electric Industries SAS
35, rue Joseph Monier
CS 30323
F-92505 Rueil Malmaison Cedex (France)

Tel.: +33 (0)1 41 29 70 00

© 2017 Schneider Electric. All Rights Reserved. Life Is On Schneider Electric is a trademark and the property of Schneider Electric SE, its subsidiaries and affiliated companies.
• N00-805